



NetCloud Services for Branch



# AER2200 Spec Sheet



*Shown: AER2200-1200M-B*

Cradlepoint AER2200 branch routers are sold as part of all-inclusive, branch networking packages.

**NetCloud Branch Essentials Packages include:**

- LTE routers, purpose built for branch applications
- A NetCloud Service Plan tailored for branch networking and set for a specific term
- 24x7 support and limited lifetime warranty

## What to Buy

Description	Part Numbers
<b>North America</b> (U.S. & Canada)	
— NetCloud Branch Essentials Package with AER2200-1200M-B	BAX-2200120B-NNN
— NetCloud Branch Essentials Package with AER2200-1200M	BAX-22001200-NNN
— NetCloud Branch Essentials Package with AER2200-600M	BAX-2200600M-NNN
<b>Europe</b>	
<i>European Union</i>	
— NetCloud Branch Essentials Package with AER2200-1200M-B-EU	BAX-2200120B-EWU
— NetCloud Branch Essentials Package with AER2200-600M-EU	BAX-2200600M-EWU
<i>United Kingdom</i>	
— NetCloud Branch Essentials Package with AER2200-1200M-B-UK	BAX-2200120B-EWE
— NetCloud Branch Essentials Package with AER2200-600M-UK	BAX-2200600M-EWE
<b>Asia-Pacific</b>	
<i>Australia, New Zealand, Singapore, &amp; Malaysia</i>	
— NetCloud Branch Essentials Package with AER2200-1200M-B-AP	BAX-2200120B-PWP
— NetCloud Branch Essentials Package with AER2200-600M-AP	BAX-2200600M-PWP
<b>All Regions</b>	
— NetCloud Branch Advanced Plan	BAX-NCADV

x = 1, 3, or 5 years

**NetCloud Branch Essentials** packages and plans contain all the features and capabilities required for small to mid-sized branch applications. Essentials Packages include 24x7 support (phone support: 24 hour weekdays with emergency response on weekends, web: 24x7, chat: 24x5) and a limited lifetime warranty.

For additional capabilities, a **NetCloud Branch Advanced Plan** can be added to the NetCloud Branch Essentials Package at any time.

See additional details of what is included in the Essential and Advanced NetCloud software: [cradlepoint.com/netcloud-manager](https://cradlepoint.com/netcloud-manager)

For more details on the AER2200 branch routers, included with the NetCloud Branch Packages, see below.

## What's in the Box

- AER2200 with embedded, LTE Advanced or LTE Advanced Pro modem
- Universal 3G/4G/LTE antennas with dedicated active GPS antenna port
- Four (4) external dual-band high-gain WiFi antennas (RP-SMA)
- AC/DC power adapter
- Ethernet cable
- Four (4) rubber feet for desk mounting
- Safety, Regulatory, and Warranty guide

## Models

AER2200-1200M-B: LTE Advanced Pro 1.2 Gbps LTE/HSPA+ with SIM-based, auto-carrier selection for all North American, European, and Asia Pacific carriers

- FirstNet® Ready (includes support for Band 14)
- Supports Private LTE (includes support for CBRS Band 48)
- Supports T-Mobile (includes support for Band 71)

AER2200-1200M: LTE Advanced Pro 1.2 Gbps LTE/HSPA+ (with SIM-based, auto-carrier selection for FirstNet, AT&T, and Verizon)

- FirstNet Ready (includes support for Band 14)

AER2200-600M: LTE Advanced 600 Mbps LTE/HSPA+ (SIM-based, auto-carrier selection for all North American, European, and Asia Pacific carriers; includes support for 700 MHz Band 28 in Asia Pacific)

- FirstNet capable (does not support Band 14)

## Key Features

### WAN

- One embedded modem
- One MC400 slot for 2nd modular modem
- Dual SIM slot in each modem
- Active GPS
- 10 10/100/1000 Ethernet ports (WAN/LAN switchable)
- WiFi-as-WAN
- Smart WAN selection
- Multi-PDN
- Failover/Failback
- Load balancing
- Advance modem failure check
- WAN port speed control
- WAN/LAN affinity
- IP passthrough
- Standby
- DynDNS
- Auto QoS
- QoS (DSCP and Priority Queuing)

### LAN

- 10 10/100/1000 Ethernet ports (WAN/LAN switchable); Supports four ports of PoE (1–4) for class I, II, III, or IV devices (default 30 W power budget, up to 120 W with accessory power supply)
- LLDP support
- VLAN 802.1Q
- DHCP Server, Client, Relay
- DNS and DNS proxy
- Split DNS
- STP
- Multicast/Multicast proxy

## WiFi

- Dual-Band Dual-Concurrent (2x2 2.4 GHz MU-MIMO and 4x4 5 GHz MU-MIMO)
- 802.11 (a/b/g/n/ac) wave 2
- Up to 248 connected devices (124 per channel – 2.4 GHz and 5 GHz)
- WPA/WPA2 personal, WPA2 Enterprise (WiFi), WEP Auto
- Hotspot/Captive portal
- SSID-based priority
- 802.11k – radio resource management - client load balancing
- 802.11r – fast roaming
- 802.11v – wireless network management

## Management

- Cradlepoint NetCloud Manager (NCM)
- Real-time diagnostics/troubleshooting
- Remote connect / OOBM
- Secure remote cloud configuration
- GeoView location services
- Web UI, API, CLI
- NetCloud Perimeter gateway support
- Client and traffic visibility and control
- SDK support
- GPS location
- Data usage alerts
- Advanced troubleshooting (support)
- Device alerts
- SNMP
- SMS control
- Console port for OOBM

## VPN & Routing

- IPsec tunnel – up to 20 concurrent sessions
- IKEv2 support (includes MOBIKE)
- OpenVPN (SSL VPN)
- L2TP1
- GRE tunnel
- OSPF/BGP/RIP
- Route filters (access control lists, prefix filters, route maps, communities for BGP)

- Policy-based routing
- Per-interface routing
- Static routing
- NAT
- NAT-less routing
- WAN affinity
- Virtual server/port forwarding
- VTI tunnel support
- NEMO/DMNR
- IPv6
- VRRP
- STP
- NHRP

## Security

- RADIUS and TACACS+ support\*
- 802.1x authentication for wireless and wired networks
- Zscaler Internet Security<sup>1</sup>
- Certificate support
- Application-level gateways
- MAC address filtering
- CP Secure Threat Management<sup>2</sup>
- Advanced security mode (local user management only)
- IP filtering
- Content filtering
- FIPS 140-2 Inside version available

## IoT Connector

- NetCloud Edge Connector for Microsoft® Azure IoT Central

\* Native support for authentication. Authorization and accounting support through hotspot/captive portal services

<sup>1</sup> Requires a [Zscaler](#) Internet Security subscription

<sup>2</sup> Requires an active Branch Advanced Plan

## Specifications

The following features are delivered through the hardware.

### WAN:

- One of the following:
  - Embedded 1200M-B LTE Advanced Pro modem (with DC-HSPA+ failover)
  - Embedded 1200M LTE Advanced Pro modem (with DC-HSPA+ failover)
  - Embedded 600M LTE Advanced modem (with DC-HSPA+ failover)
- MC400 slot for optional 2nd modular modem
- 10 10/100/1000 ethernet ports (cable/DSL/T1/satellite/Metro Ethernet; WAN/LAN switchable)
- WiFi (as WAN; Metro WiFi) 2x2 MIMO 2.4 GHz and 4x4 MIMO 5 GHz (802.11 a/b/g/n/ac)

### LAN:

- Dual-band, dual-concurrent WiFi (802.11 a/b/g/n/ac wave 2)
- 10 10/100/1000 ethernet ports (WAN/LAN switchable)
- Serial console

### Temperature:

- 0 °C to 50 °C (32 °F to 122 °F) operating
- -20 °C to 70 °C (-4 °F to 158 °F) storage

### Humidity (non-condensing):

- 5% to 95% operating
- 5% to 95% storage

**Memory:** 512 MB DRAM; 8 GB eMMC

### Size:

- 7.3 × 8.3 × 1.7 in (185 × 210 × 44 mm)
- 1U height for rack mount

**Weight:** 3 lb 5 oz (1.5 kg)

### Certifications:

- WiFi Alliance – 802.11a/b/g/n/ac wave 2 certified
  - Safety: UL/CUL, CB Scheme, EN60950-1
  - Materials: WEEE, RoHS, RoHS-2, California Prop 65
  - Telecom: PTCRB/CTIA, GCF-CC
  - FIPS 140-2 Inside versions available

### WiFi Power (FCC):

- 2402–2483.5 MHz (2.4 GHz band): 28.3 dBm conducted
- 5150–5250 MHz (5 GHz band 1): 29.1 dBm conducted
- 5725–5850 MHz (5 GHz band 3): 30.0 dBm conducted

**WiFi Power (Europe/Rest of World):**

- 2.4 GHz band: 19.88 dBm EIRP
- 5150-5250 MHz: 22.96 dBm EIRP

**GPS:** Modem-based GPS

## Performance

- Max Throughput (Default Configuration\*): 950 Mbps
- Max Concurrent TCP Sessions: 32,000
- Recommended Max Client Count: 100\*\*

Performance testing was conducted based off requirements as defined in RFC2544 using a mix of 64, 256, and 1500-byte packet sizes. Throughput is shown as bi-directional TCP traffic with less than a 1% packet loss using four wired clients.

Specifications and information in this datasheet are subject to change without notice.

\* Default configuration shipped with hardware including NAT and basic stateful/zone firewall configuration.

\*\* Cradlepoint defines client as any network connected device utilizing resources, such as bandwidth, on the local network.

## Enterprise-Class Modem Specifications

### AER2200-1200M-B for Worldwide

AER2200-1200M-B models include an embedded LTE Advanced Pro 1.2 Gbps 4G LTE modem. The 1200M-B modem supports SIM-based, auto-carrier selection. Simply insert the SIM and wait for the router to automatically detect the SIM and establish a connection.

- Technology: Category 18 LTE Advanced Pro, DC-HSPA+ with SIM-based, auto-carrier selection
- Modem Downlink Rates: LTE 1.2 Gbps, DC-HSPA+ 42.2 Mbps\*
- Modem Uplink Rates: LTE 150 Mbps, DC-HSPA+ 5.76 Mbps\*
- MIMO: 2x2 MIMO or 4x4 MIMO
- 256 QAM support
- Frequency Bands:
  - LTE Bands
    - LTE FDD: 2(25), 4(66), 5(26/18/19), 7, 8, 12(17), 13, 14, 20, 28, 29, 30, 32, 71
    - LTE TDD: 38, 39, 40, 41, 42, 43, 46, 48
- Carrier Aggregation: Up to 5CA
  - AT&T:
    - LTE Bands
      - LTE FDD: 2, 4, 5, 12, 13, 14, 17, 25, 26, 29 (DL), 30, 66, 71 (FDD)
      - LTE TDD: 41, 46, (DL), 48



- 3G DC-HSPA+: 1, 2, 4, 5, 8
- 2CA DL carrier aggregation combinations:
  - CA\_2A-4A, CA\_2A-5A, CA\_2A-12A, CA\_2A-14A, CA\_2A-29A, CA\_2A-66A, CA\_2A-71A, CA\_4A-5A, CA\_4A-12A, CA\_4A-29A, CA\_4A-71A, CA\_5A-66A, CA\_12A-66A, CA\_14A-66A, CA\_25A-26A, CA\_29A-66A, CA\_66A-71A, CA\_2A-2A, CA\_4A-4A, CA\_25A-25A, CA\_66A-66A, CA\_2C, CA\_5B, CA\_12B, CA\_66B, CA\_66C
- 3CA DL carrier aggregation combinations:
  - CA\_2A-2A-5A, CA\_2A-2A-12A, CA\_2A-2A-66A, CA\_2A-2A-71A, CA\_2A-4A-4A, CA\_2A-4A-5A, CA\_2A-4A-12A, CA\_2A-4A-29A, CA\_2A-4A-71A, CA\_2A-5A-66A, CA\_2A-12A-66A, CA\_2A-12B, CA\_2A-14A-66A, CA\_2A-66A-66A, CA\_2A-66A-71A, CA\_2A-66C, CA\_2A-66C, CA\_4A-4A-5A, CA\_4A-4A-12A, CA\_4A-4A-71A, CA\_4A-12B, CA\_5A-66A-66A, CA\_5A-66C, CA\_12A-66A-66A, CA\_12A-66C, CA\_14A-66A-66A, CA\_25A-25A-26A, CA\_29A-66A-66A, CA\_66A-66A-71A
- 4CA DL carrier aggregation combinations:
  - CA\_2A-2A-5A-66A, CA\_2A-2A-12A-66A, CA\_2A-2A-66A-66A, CA\_2A-2A-66A-71A, CA\_2A-2A-66C, CA\_2A-4A-4A-12A, CA\_2A-5A-66A-66A, CA\_2A-5B-66A, CA\_2A-12A-66A-66A, CA\_2A-66A-66A-71A, CA\_2A-66C-71A, CA\_2C-66A-66A, CA\_5B-66A-66A,
- 5CA DL carrier aggregation combinations: CA\_2A-5B-66A-66A,
- 2CA UL carrier aggregation combinations: UL\_2A-5A, UL\_2A-12A, UL\_4A-12A, UL\_5A-66A, UL\_5B
- Verizon
  - LTE Bands
    - LTE FDD: 2, 4, 5, 13, 66 (FDD)
  - 3G DC-HSPA+: 1, 2, 4, 5, 8 (roaming)
  - 2CA DL carrier aggregation combinations:
    - CA\_2A-2A, CA\_2A-4A, CA\_2A-5A, CA\_2A-13A, CA\_2A-66A, CA\_4A-4A, CA\_4A-5A, CA\_4A-13A, CA\_5A-66A, CA\_5B, CA\_13A-66A, CA\_66A-66A, CA\_66B, CA\_66C,
  - 3CA DL carrier aggregation combinations:
    - CA\_2A-2A-5A, CA\_2A-2A-13A, CA\_2A-2A-66A, CA\_2A-4A-5A, CA\_2A-4A-13A, CA\_2A-5A-66A, CA\_2A-13A-66A, CA\_2A-66A-66A, CA\_2A-66B, CA\_2A-66C, CA\_4A-4A-5A, CA\_4A-4A-13A, CA\_5A-66A-66A, CA\_5A-66B, CA\_5A-66C, CA\_13A-66A-66A, CA\_13A-66B, CA\_13A-66C, CA\_66A-66C, CA\_66D
  - 2CA UL carrier aggregation combinations: CA\_2A-13A, CA\_4A-13A
- North America Generic:
  - LTE Bands
    - LTE FDD: 2, 4, 5, 12, 13, 14, 17, 25, 26, 29 (DL), 30, 66, 71 (FDD)
    - LTE TDD: 41, 46 (DL), 48
  - 3G DC-HSPA+: 1, 2, 4, 5, 8
  - 2CA DL carrier aggregation combinations:
    - CA\_[2A]-[4A], CA\_[2A]-5A, CA\_2A-7A, CA\_[2A]-12A, CA\_[2A]-14A, CA\_[2A]-29A, CA\_2A-30A, CA\_[2A]-46A, CA\_[2A]-48A, CA\_[2A]-[66A], CA\_[2A]-71A, CA\_[4A]-5A, CA\_4A-7A, CA\_[4A]-12A, CA\_[4A]-29A, CA\_4A-30A, CA\_[4A]-46A, CA\_[4A]-71A, CA\_5A-30A, CA\_5A-[66A], CA\_7A-12A, CA\_12A-30A, CA\_12A-[66A], CA\_14A-30A, CA\_14A-[66A], CA\_[25A]-26A, CA\_25A-41A, CA\_26A-[41A], CA\_29A-30A, CA\_29A-[66A], CA\_30A-66A, CA\_46A-[66A], CA\_48A-[66A], CA\_[66A]-71A, CA\_[2A]-[2A], CA\_[4A]-[4A], CA\_[25A]-[25A], CA\_[41A]-[41A], CA\_48A-48A, CA\_[66A]-[66A], CA\_[2C], CA\_5B, CA\_7C, CA\_12B, CA\_[41C], CA\_48C, CA\_[66B], CA\_[66C]

— 3CA DL carrier aggregation combinations:

CA\_[2A]-2A-5A, CA\_2A-[2A]-5A, CA\_[2A]-2A-12A, CA\_2A-[2A]-12A, CA\_2A-2A-30A, CA\_[2A]-2A-66A, CA\_2A-[2A]-66A, CA\_2A-2A-[66A], CA\_[2A]-2A-71A, CA\_2A-[2A]-71A, CA\_[2A]-4A-4A, CA\_2A-[4A]-4A, CA\_2A-4A-[4A], CA\_[2A]-4A-5A, CA\_2A-[4A]-5A, CA\_[2A]-4A-12A, CA\_2A-[4A]-12A, CA\_[2A]-4A-29A, CA\_2A-[4A]-29A, CA\_2A-4A-30A, CA\_[2A]-4A-71A, CA\_2A-[4A]-71A, CA\_2A-5A-30A, CA\_[2A]-5A-66A, CA\_2A-5A-[66A], CA\_2A-7A-12A, CA\_2A-12A-30A, CA\_[2A]-12A-66A, CA\_2A-12A-[66A], CA\_[2A]-12B, CA\_2A-14A-30A, CA\_[2A]-14A-66A, CA\_2A-14A-[66A], CA\_2A-29A-30A, CA\_2A-30A-66A, CA\_[2A]-46A-46A, CA\_[2A]-46A-66A, CA\_2A-46A-[66A], CA\_[2A]-46C, CA\_[2A]-48A-48A, CA\_[2A]-48C, CA\_[2A]-48A-66A, CA\_2A-48A-[66A], CA\_[2A]-66A-66A, CA\_2A-[66A]-66A, CA\_2A-66A-[66A], CA\_[2A]-66A-71A, CA\_2A-[66A]-71A, CA\_[2A]-[66C], CA\_[2A]-66C, CA\_2A-[66C], CA\_[4A]-4A-5A, CA\_4A-[4A]-5A, CA\_4A-4A-7A, CA\_[4A]-4A-12A, CA\_4A-[4A]-12A, CA\_4A-4A-30A, CA\_[4A]-4A-71A, CA\_4A-[4A]-71A, CA\_4A-5A-30A, CA\_4A-7A-12A, CA\_4A-12A-30A, CA\_[4A]-12B, CA\_4A-29A-30A, CA\_[4A]-46A-46A, CA\_[4A]-46C, CA\_5A-30A-66A, CA\_5A-[66A]-66A, CA\_5A-66A-[66A], CA\_5A-[66C], CA\_12A-30A-66A, CA\_12A-[66A]-66A, CA\_12A-66A-[66A], CA\_12A-[66C], CA\_14A-30A-66A, CA\_14A-[66A]-66A, CA\_14A-66A-[66A], CA\_[25A]-25A-26A, CA\_25A-[25A]-26A, CA\_25A-41C, CA\_26A-[41C], CA\_29A-30A-66A, CA\_29A-[66A]-66A, CA\_29A-66A-[66A], CA\_30A-66A-66A, CA\_[41A]-[41C], CA\_[41A]-41C, CA\_41A-[41C], CA\_[41D], CA\_46C-[66A], CA\_48A-48C, CA\_48D, CA\_48A-48A-[66A], CA\_48C-[66A], CA\_[66A]-66A-71A, CA\_66A-[66A]-71A

— 4CA DL carrier aggregation combinations:

CA\_2A-2A-5A-30A, CA\_2A-2A-5A-66A, CA\_2A-2A-12A-30A, CA\_2A-2A-12A-66A, CA\_2A-2A-29A-30A, CA\_2A-2A-66A-66A, CA\_2A-2A-66A-71A, CA\_[2A]-2A-66C, CA\_2A-[2A]-66C, CA\_2A-2A-[66C], CA\_2A-4A-4A-12A, CA\_2A-4A-5A-30A, CA\_2A-4A-7A-12A, CA\_2A-4A-12A-30A, CA\_2A-5A-30A-66A, CA\_2A-5A-66A-66A, CA\_2A-5B-30A, CA\_[2A]-5B-66A, CA\_2A-5B-[66A], CA\_2A-12A-30A-66A, CA\_2A-12A-66A-66A, CA\_2A-29A-30A-66A, CA\_2A-46A-46A-66A, CA\_[2A]-46A-46C, CA\_[2A]-46C-66A, CA\_2A-46C-[66A], CA\_[2A]-46D, CA\_2A-66A-66A-71A, CA\_2A-66C-71A, CA\_[2C]-66A-66A, CA\_2C-[66A]-66A, CA\_2C-66A-[66A], CA\_4A-4A-12A-30A, CA\_[4A]-46A-46C, CA\_[4A]-46D, CA\_5A-30A-66A-66A, CA\_5B-30A-66A, CA\_5B-66A-66A, CA\_12A-30A-66A-66A, CA\_25A-41D, CA\_29A-30A-66A-66A, CA\_[41A]-41D, CA\_[41C]-41C, CA\_41C-[41C], CA\_41E, CA\_46A-46C-[66A], CA\_46D-[66A], CA\_48D-[66A], CA\_48E

— 5CA DL carrier aggregation combinations:

CA\_2A-2A-46D, CA\_2A-5B-30A-66A, CA\_2A-5B-66A-66A, CA\_2A-46A-46C-66A, CA\_2A-46D-66A, CA\_5B-30A-66A-66A, CA\_46D-66A-66A

— 2CA UL carrier aggregation combinations:

UL\_2A-5A, UL\_2A-12A, UL\_4A-12A, UL\_5A-66A, UL\_5B, UL\_41C

— EU/APAC Generic:

— LTE Bands:

- LTE FDD: 1, 2, 3, 4, 5, 7, 8, 12, 13, 14, 17, 18, 19, 20, 25, 26, 28, 29 (DL), 30, 32, 66, 71
- LTE TDD: 38, 39, 40, 41, 42, 43, 46 (DL), 48

— 3G DC-HSPA+: 1, 2, 4, 5, 8, 9, 19

— 2CA DL carrier aggregation combinations:

CA\_1A-3A, CA\_1A-5A, CA\_1A-7A, CA\_1A-8A, CA\_1A-18A, CA\_1A-19A, CA\_1A-20A, CA\_1A-26A, CA\_1A-28A, CA\_1A-32A, CA\_1A-38A, CA\_1A-40A, CA\_1A-41A, CA\_1A-42A, CA\_[2A]-[4A], CA\_[2A]-5A, CA\_[2A]-7A, CA\_[2A]-12A, CA\_[2A]-28A, CA\_[2A]-46A, CA\_[2A]-48A, CA\_[2A]-[66A], CA\_[2A]-71A, CA\_3A-5A, CA\_3A-7A, CA\_3A-8A, CA\_3A-19A, CA\_3A-20A, CA\_3A-26A, CA\_3A-28A, CA\_3A-32A, CA\_3A-38A, CA\_3A-40A, CA\_3A-42A, CA\_[4A]-5A, CA\_4A-7A, CA\_[4A]-12A, CA\_[4A]-28A, CA\_[4A]-46A, CA\_5A-7A, CA\_7A-8A, CA\_7A-12A, CA\_7A-20A, CA\_7A-28A, CA\_7A-42A, CA\_8A-38A, CA\_8A-40A, CA\_8A-42A, CA\_12A-[66A], CA\_20A-32A, CA\_20A-38A, CA\_20A-40A, CA\_20A-42A, CA\_26A-[41A], CA\_28A-40A, CA\_28A-42A, CA\_39A-41A, CA\_40A-42A, CA\_46A-[66A], CA\_48A-[66A], CA\_[66A]-71A, CA\_1A-1A, CA\_[2A]-[2A], CA\_3A-3A, CA\_[4A]-[4A], CA\_7A-7A, CA\_40A-40A, CA\_42A-42A, CA\_48A-48A, CA\_[66A]-[66A], CA\_[2C], CA\_3C, CA\_7B, CA\_7C, CA\_8B, CA\_12B, CA\_38C, CA\_39C, CA\_40C, CA\_[41C], CA\_42C, CA\_48C, CA\_[66B], CA\_[66C]

— 3CA DL carrier aggregation combinations:

CA\_1A-1A-3A, CA\_1A-3A-3A, CA\_1A-3A-7A, CA\_1A-3A-8A, CA\_1A-3A-19A, CA\_1A-3A-20A, CA\_1A-3A-28A, CA\_1A-3A-32A, CA\_1A-3A-38A, CA\_1A-3A-40A, CA\_1A-3A-41A, CA\_1A-3A-42A, CA\_1A-3C, CA\_1A-7A-7A, CA\_1A-7A-8A, CA\_1A-7A-20A, CA\_1A-7A-28A, CA\_1A-7A-42A, CA\_1A-7C, CA\_1A-8A-40A, CA\_1A-20A-32A, CA\_1A-20A-42A, CA\_1A-28A-42A, CA\_1A-40C, CA\_1A-41C, CA\_1A-42C, CA\_1A-46C, CA\_1C-3A, CA\_[2A]-2A-12A, CA\_2A-[2A]-12A, CA\_[2A]-2A-66A, CA\_2A-[2A]-66A, CA\_2A-2A-[66A], CA\_[2A]-2A-71A, CA\_2A-[2A]-71A, CA\_[2A]-4A-4A, CA\_2A-[4A]-4AC, CA\_2A-4A-[4A], CA\_[2A]-4A-5A, CA\_2A-[4A]-5A, CA\_[2A]-4A-12A, CA\_2A-[4A]-12A, CA\_[2A]-4A-29A, CA\_2A-[4A]-29A, CA\_[2A]-4A-71A, CA\_2A-[4A]-71A, CA\_2A-7A-12A, CA\_[2A]-12A-66A, CA\_2A-12A-[66A], CA\_[2A]-12B, CA\_[2A]-46A-46A, CA\_[2A]-46A-66A, CA\_2A-46A-[66A], CA\_[2A]-46C, CA\_[2A]-48A-48A, CA\_[2A]-48C, CA\_[2A]-48A-66A, CA\_2A-48A-[66A], CA\_[2A]-66A-66A, CA\_2A-[66A]-66A, CA\_2A-66A-[66A], CA\_[2A]-66A-71A, CA\_2A-[66A]-71A, CA\_[2A]-[66C], CA\_[2A]-66C, CA\_2A-[66C], CA\_3A-3A-7A, CA\_3A-3A-8A, CA\_3A-3A-20A, CA\_3A-3A-28A, CA\_3C-5A, CA\_3A-7A-7A, CA\_3A-7A-8A, CA\_3A-7A-20A, CA\_3A-7A-28A, CA\_3A-7A-42A, CA\_3A-7B, CA\_3A-7C, CA\_3C-7A, CA\_3A-8A-38A, CA\_3A-8A-40A, CA\_3C-8A, CA\_3A-20A-32A, CA\_3A-20A-42A, CA\_3A-28A-40A, CA\_3A-28A-42A, CA\_3C-20A, CA\_3C-28A, CA\_3A-40A-40A, CA\_3A-40C, CA\_3A-42A-42A, CA\_3A-42C, CA\_3A-46C, CA\_3C-32A, CA\_3C-38A, CA\_3C-40A, CA\_4A-4A-7A, CA\_[4A]-4A-12A, CA\_4A-[4A]-12A, CA\_[4A]-4A-71A, CA\_4A-[4A]-71A, CA\_4A-7A-12A, CA\_[4A]-12B, CA\_[4A]-46A-46A, CA\_[4A]-46C, CA\_7A-7A-8A, CA\_7A-20A-42A, CA\_7C-20A, CA\_7B-28A, CA\_7C-28A, CA\_7A-46C, CA\_8A-40C, CA\_8A-42C, CA\_12A-[66A]-66A, CA\_12A-66A-[66A], CA\_12A-[66C], CA\_19A-42C, CA\_20A-38C, CA\_28A-40C, CA\_28A-42C, CA\_40A-40C, CA\_40D, CA\_40A-42C, CA\_40C-42A, CA\_42A-42C, CA\_42D, CA\_46C-[66A], CA\_48A-48C, CA\_48D, CA\_48A-48A-[66A], CA\_48C-[66A], CA\_[66A]-66A-71A, CA\_66A-[66A]-71A

— 4CA DL carrier aggregation combinations:

CA\_1A-1A-3A-28A, CA\_1A-3A-3A-28A, CA\_1A-3A-7A-7A, CA\_1A-3A-7C, CA\_1A-3A-7A-8A, CA\_1A-3A-7A-20A, CA\_1A-3A-7A-28A, CA\_1A-3A-8A-40A, CA\_1A-3A-3A-8A, CA\_1A-3A-40C, CA\_1A-3A-42C, CA\_1A-3C-5A, CA\_1A-3C-7A, CA\_1A-3C-8A, CA\_1A-3C-28A, CA\_1A-7C-28A, CA\_1A-42D, CA\_1A-46D, CA\_2A-2A-12A-66A, CA\_2A-2A-66A-66A, CA\_2A-2A-66A-71A, CA\_[2A]-2A-66C, CA\_2A-[2A]-66C, CA\_2A-2A-[66C], CA\_2A-4A-7A-12A, CA\_2A-12A-66A-66A, CA\_2A-46A-46A-66A, CA\_[2A]-46A-46C, CA\_[2A]-46C-66A, CA\_2A-46C-[66A], CA\_[2A]-46D, CA\_[2C]-66A-66A, CA\_2C-[66A]-66A, CA\_2C-66A-[66A], CA\_3A-3A-7A-7A, CA\_3A-3A-7A-8A, CA\_3A-3A-7A-20A, CA\_3A-3A-7A-28A, CA\_3A-5A-7A-7A, CA\_3A-7A-7A-8A, CA\_3A-7C-20A, CA\_3A-7C-28A, CA\_3A-28A-40C, CA\_3A-28A-42C, CA\_3A-40D, CA\_3A-46D, CA\_3C-7A-20A, CA\_3C-7A-28A, CA\_3C-7C, CA\_3C-40C, CA\_[4A]-46A-46C, CA\_[4A]-46D, CA\_7A-46D, CA\_28A-40D, CA\_28A-46D, CA\_40C-40C, CA\_40C-42C, CA\_40E, CA\_[41C]-42C, CA\_42C-42C, CA\_42E, CA\_46A-46C-[66A], CA\_46D-[66A], CA\_48D-[66A], CA\_48E

— 5CA DL carrier aggregation combinations:

CA\_1A-3A-7C-28A, CA\_1A-3C-7C, CA\_1A-3C-40C, CA\_2A-46A-46C-66A, CA\_2A-46D-66A, CA\_3A-28A-40D, CA\_3C-7C-28A, CA\_3A-40E

— 2CA UL carrier aggregation combinations:

CA\_1A-7A, CA\_1A-8A, CA\_1A-28A, CA\_3A-7A, CA\_3A-8A, CA\_3A-20A, CA\_3A-28A, CA\_4A-7A, CA\_3C, CA\_7C, CA\_38C, CA\_39C, CA\_40C, CA\_41C, CA\_42C

- fallback: WCDMA/DC-HSPA+ (42/5.76 Mbps): Bands 1, 2, 4, 5, 8
- Power: LTE 23 dBm ± 1, DC-HSPA+ 23 dBm ± 1
- Antennas: SMA & RP-SMA male plugs, maximum torque not to exceed 4 in-lbs
- GPS: Active GPS support
- SMS: SMS support
- Industry Standards & Certs: FCC (includes Part 96), IC, CE, PTCRB, GCF-CC, ESN, AT&T, FirstNet Ready, Verizon, RCM (Australia/New Zealand), Pending: ICASA (South Africa)

**AER2200-1200M-NA**

AER2200-1200M models include an embedded LTE Advanced Pro 1.2 Gbps 4G LTE modem. The 1200M modem supports SIM-based, auto-carrier selection for FirstNet, AT&T, and Verizon. Simply insert the SIM and wait for the router to automatically detect the SIM and establish a connection.

- Technology: Category 18 LTE Advanced Pro, DC-HSPA+
- Downlink Rates: LTE 1.2 Gbps, DC-HSPA+ 42.2 Mbps\*
- Uplink Rates: LTE 150 Mbps, DC-HSPA+ 5.76 Mbps\*
- MIMO: 2x2 or 4x4 MIMO
- 256 QAM support
- Frequency Bands:
  - LTE Bands:
    - LTE FDD: 2, 4(66), 5, 12, 13, 14, 29, 30
    - LTE TDD: 46,48
- Carrier Aggregation: Up to 5CA. [ ] indicates 4x4 MIMO
  - AT&T: 2,4,5,12,14,29,30,66,46; 3G 2, 5
    - 2CA DL carrier aggregation combinations:  
CA\_[2A]-[2A], CA\_[2A]-[4A], CA\_2A-5A, CA\_2A-12A, CA\_2A-14A, CA\_2A29A, CA\_2A-30A, CA\_[2A]-46A, CA\_[2A]-[66A], CA\_2C, CA\_[4A]-[4A], CA\_4A-5A, CA\_4A-12A, CA\_4A-29A, CA\_4A-30A, CA\_[4A]-46A, CA\_5A30A, CA\_5A-66A, CA\_5B, CA\_12A-30A, CA\_12A-66A, CA\_12B, CA\_14A30A, CA\_14A-66A, CA\_29A-30A, CA\_29A-66A, CA\_30A-66A, CA\_[66A][66A], CA\_66B, CA\_66C
    - 3CA DL carrier aggregation combinations:  
CA\_2A-2A-5A, CA\_[2A]-2A-12A, CA\_2A-2A-14A, CA\_2A-2A-30A, CA\_2A2A-66A, CA\_[2A]-4A-4A, CA\_2A-[4A]-[4A], CA\_[2A]-4A-5A, CA\_2A-[4A]-5A, CA\_[2A]-4A-12A, CA\_2A-[4A]-12A, CA\_2A-4A-30A, CA\_2A-5A-30A, CA\_[2A]-5A-66A, CA\_2A-5A-[66A], CA\_2A-12A-30A, CA\_[2A]-12A-66A, CA\_2A-12A-[66A], CA\_2A-14A-30A, CA\_2A-14A-66A, CA\_2A-29A-30A, CA\_2A-30A-66A, CA\_2A-46C, CA\_2A-66A-66A, CA\_[4A]-4A-5A, CA\_[4A]4A-12A, CA\_4A-4A-30A, CA\_4A-5A-30A, CA\_4A-12A-30A, CA\_4A-12B, CA\_4A-29A-30A, CA\_5A-30A-66A, CA\_5A-66A-66A, CA\_5A-66C, CA\_12A30A-66A, CA\_12A-[66A]-66A, CA\_14A-30A-66A, CA\_14A-66A-66A, CA\_29A-30A-66A, CA\_29A-66A-66A, CA\_30A-66A-66A
    - 4CA DL carrier aggregation combinations:  
CA\_2A-2A-5A-30A, CA\_2A-2A-5A-66A, CA\_2A-2A-12A-30A, CA\_2A-2A12A-66A, CA\_2A-2A-14A-66A, CA\_2A-2A-29A-30A, CA\_2A-2A-66A-66A, CA\_2A-4A-4A-12A, CA\_2A-4A-5A-30A, CA\_2A-4A-12A-30A, CA\_2A-5A30A-66A, CA\_2A-5A-66A-66A, CA\_2A-5B-30A, CA\_2A-5B-66A, CA\_2A12A-30A-66A, CA\_2A-12A-66A-66A, CA\_2A-14A-30A-66A, CA\_2A-14A66A-66A, CA\_2A-29A-30A-66A, CA\_[2A]-46D, CA\_[4A]-46D, CA\_4A-4A12A-30A, CA\_5A-30A-66A-66A, CA\_5B-30A-66A, CA\_5B-66A-66A, CA\_12A-30A-66A-66A, , CA\_14A-30A-66A-66A, CA\_29A-30A-66A-66A, CA\_46D-[66A]
    - 5CA DL carrier aggregation combinations:  
CA\_2A-2A-46D, CA\_2A-5B-30A-66A, CA\_2A-5B-66A-66A, CA\_2A-46D66A, CA\_5B-30A-66A-66A, CA\_46D-66A-66A
    - 2CA UL carrier aggregation combinations:  
CA\_2A-12A, CA\_2A-5A, CA\_4A-12A, CA\_5A-66A, CA\_5B, CA\_12A-66A
  - Verizon: 2, 4, 5, 13, 66, 48; 3G (roaming): 1, 2, 4, 5, 8
    - 2CA DL carrier aggregation combinations:  
CA\_[2A]-[2A], CA\_[2A]-[4A], CA\_[2A]-5A, CA\_[2A]-13A, CA\_[2A]-[66A], CA\_[4A]-[4A], CA\_[4A]-5A, CA\_[4A]-13A, CA\_5A-[66A], CA\_5B, CA\_13A[66A], CA\_[66A]-[66A], CA\_[66B], CA\_[66C], CA\_[2A]-48A, CA\_13A-48A, CA\_48A-[66A]

- 3CA DL carrier aggregation combinations:  
 CA\_[2A]-2A-5A, CA\_[2A]-2A-13A, CA\_[2A]-2A-66A, CA\_2A-2A-[66A], CA\_[2A]-4A-5A, CA\_2A-[4A]-5A, CA\_[2A]-4A-13A, CA\_2A-[4A]-13A, CA\_[2A]-5A-66A, CA\_2A-5A-[66A], CA\_[2A]-13A-66A, CA\_2A-13A-[66A], CA\_[2A]-66A-66A, CA\_2A-[66A]-66A, CA\_[2A]-[66B], CA\_[2A]-[66C], CA\_[4A]-4A-5A, CA\_[4A]-4A-13A, CA\_5A-[66A]-66A, CA\_5A-[66B], CA\_5A[66C], CA\_13A-[66A]-66A, CA\_13A-[66B], CA\_13A-[66C], CA\_[66A]-[66C], CA\_[66D], CA\_[2A]-48A-48A, CA\_[2A]-48A-66A, CA\_2A-48A-[66A], CA\_[2A]-48C, CA\_13A-48A-48A, CA\_13A-48A-[66A], CA\_13A-48C, CA\_48A-48A-[66A], CA\_48A-[66A]66A, CA\_48A-[66B], CA\_48C-[66A]
- 4CA DL carrier aggregation combinations:  
 CA\_2A-48A-48A-66A, CA\_[2A]-48D, CA\_13A-48A-48A-66A, CA\_13A-48A-48C, CA\_13A-48C-[66A], CA\_13A-48D, CA\_48A-48A-66A-66A, CA\_48A-48A-[66B], CA\_48A-48A-[66C], CA\_48A-48C-[66A], CA\_48D-[66A]
- 5CA DL carrier aggregation combinations:  
 CA\_2A-48E, CA\_13A-48A-48C-66A, CA\_13A-48C-48C, CA\_13A-48D-66A, CA\_13A-48E, CA\_48A-48C-66B, CA\_48A-48C-66C, CA\_48C-48C-66A, CA\_48E-66A
- Fallback: WCDMA/DC-HSPA+ (42/5.76 Mbps): Bands 1, 2, 4, 5(19), 8
- Power: LTE 23 dBm ± 1, DC-HSPA+ 23 dBm ± 1
- Antennas: SMA & RP-SMA male plugs, maximum torque not to exceed 4 in-lbs
- GPS: Active GPS support
- SMS: SMS support
- Industry Standards & Certs: FCC, IC, PTCRB, AT&T, FirstNet, Verizon

**AER2200-600M-NA, -EU, -AP**

AER2200-600M models include an embedded LTE Advanced 600 Mbps 4G LTE modem. The 600M modems support worldwide, SIM-based, Auto-carrier selection. Simply insert the SIM and wait for the router to automatically detect the SIM and establish a connection.

The LTE bands certified for each carrier are listed below.

- Technology: LTE Advanced, DC-HSPA+
- Downlink Rates: LTE 600 Mbps\*, DC-HSPA+ 42.2 Mbps\*
- Uplink Rates: LTE 75 Mbps, DC-HSPA+ 5.76 Mbps\*
- Frequency Bands:
  - LTE Bands
    - LTE FDD: 1–5, 7–8, 12–13, 17, 20, 25–26, 28–30, 66
    - LTE TDD: 38, 40–41
  - HSPA+: 1–2, 4–5, 8
  - LTE 2DL Carrier Aggregation Combinations:  
 B2+B2, B2+B4, B2+B5, B2+B12, B2+B13, B2+B17, B2+B29, B2+B30, B4+B4, B4+B5, B4+B7, B4+B12, B4+B13, B4+B17, B4+B29, B4+B30, B5+B30, B12+B12, B12+B30, B25+B25, B25+B26, B25+B41, B26+B41, B29+B30, B41+B41, B1+B20, B3+B3, B3+B7, B3+B20, B3+B38, B7+B7, B7+B8, B7+B20, B38+B38, B1+B3, B1+B7, B1+B28, B3+B8, B3+B28, B5+B7, B5+B40, B7+B8, B7+B20

— LTE 3DL Carrier Aggregation Combinations:

B2+B2+B12/17, B2+B2+B13, B2+B2+B4, B2+B4+B5, B2+B4+B12, B2+B4+B13, B2+B4+B29,B2+B5+B30, B2+B12+B12, B2+B12+B30, B2+B29+B30, B4+B4+B5, B4+B4+B7, B4+B4+B12, B4+B4+B13, B4+B5+B30, B4+B12+B12, B4+B12+B30, B4+B29+B30, B25+B26+B41, B25+B41+B41, B26+B41+B41, B41+B41+B41, B1+B3+B20, B1+B7+B20, B3+B3+B7, B3+B3+B20, B3+B7+B20, B3+B7+B7, B3+B20+B38, B3+B38+B38, B3+B3+B5, B3+B3+B8, B3+B7+B7, B3+B7+B28, B7+B7+B28, B28+B40+B40, B40+B40+B40

- Fallback: WCDMA/DC-HSPA+ (42/5.76 Mbps): Bands 1, 2, 4, 5, 8
- Power: LTE: 23 dBm ±1; DC-HSPA+: 23 dBm ±1
- Antennas: SMA & RP-SMA male plugs, maximum torque not to exceed 4 in-lbs
- GPS: Active GPS support
- SMS: SMS support
- Industry Standards & Certs: CE, FCC, GCF-CC, IC, PTCRB, AT&T, Sprint, Verizon, Verizon NEMO/DMNR for Primary Wireless Access, RCM (Australia/New Zealand), ICASA (South Africa)

\* Theoretical

\*\* To be enabled with a future modem software update.

## Accessories

The following are optional, compatible accessories to enhance the functionality of the AER2200 branch router.

- Second modular 4G LTE modem (refer to the [Cradlepoint MC400 Modular Modem](#) webpage for more information):
  - MC400-1200M-B
  - MC400-1200M
  - MC400LP6 (North America or EU)
  - MC400LP5 (Asia Pacific or Saudi Arabia)
  - MC400LP4 (AT&T, Verizon, T-Mobile and Canada)
  - MC400LPE-VZ (Verizon)
  - MC400LPE-AT (AT&T)
  - MC400LPE-SP (Sprint)
  - MC400LPE-GN (generic — for use on T-Mobile in the U.S. and Rogers, Bell, & TELUS in Canada)
  - MC400LP3-EU (Europe)
- Black, Universal 600MHz-6GHz 3G/4G/LTE 2dBi/3dBi 6" antenna with SMA connector (1x) (Part # 170760-000)
- AER2200 high-power supply for up to 4 ports of PoE+ .at (30W) power (120W PoE budget) (Part # 170751-000)
- AER2200, 54V 2.22A (60W PoE budget) power supply (C14 line cord not included) (Part # 170671-000)
- 2.4/5 GHz Dual-band Dual-concurrent WiFi Antenna (Part # 170628-000)

## Support & Warranty

The AER2200 is only sold as a component of NetCloud Branch Packages.

- NetCloud Packages include support for the full subscription term.
- All Cradlepoint hardware products are covered by a limited lifetime warranty for as long as they have a subscription license to an active NetCloud Service Plan.

All specifications subject to change without notice.

FirstNet and FirstNet Ready are registered trademarks and service marks of the First Responder Network Authority, an independent authority within the U.S. Department of Commerce.

## Hardware

### Top & Side View

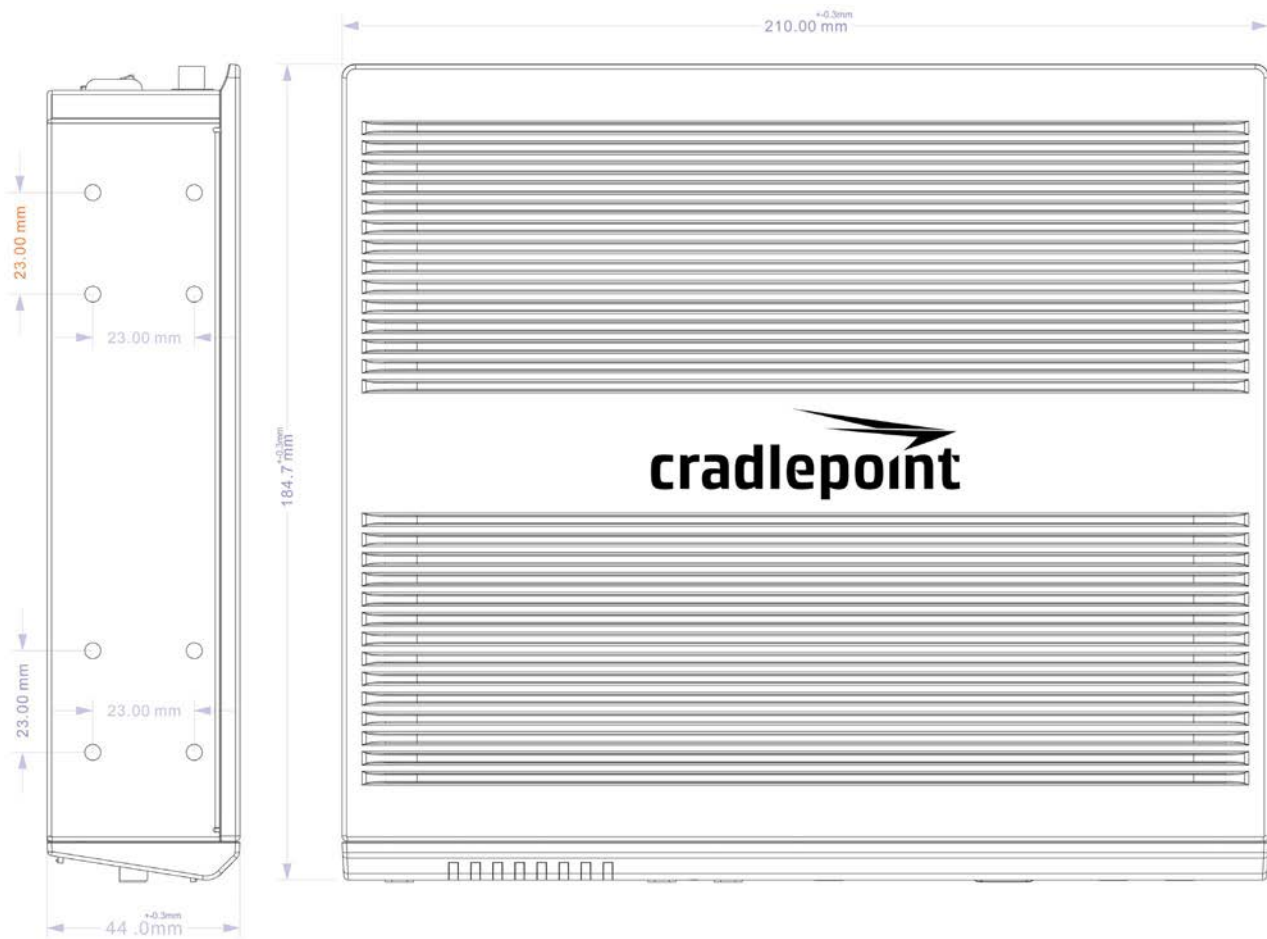

Back

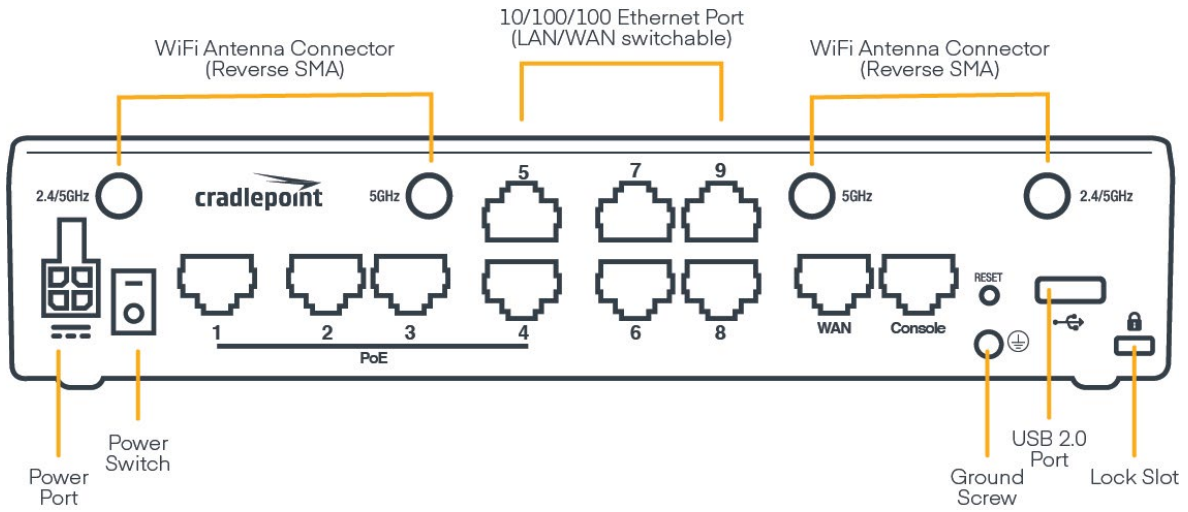



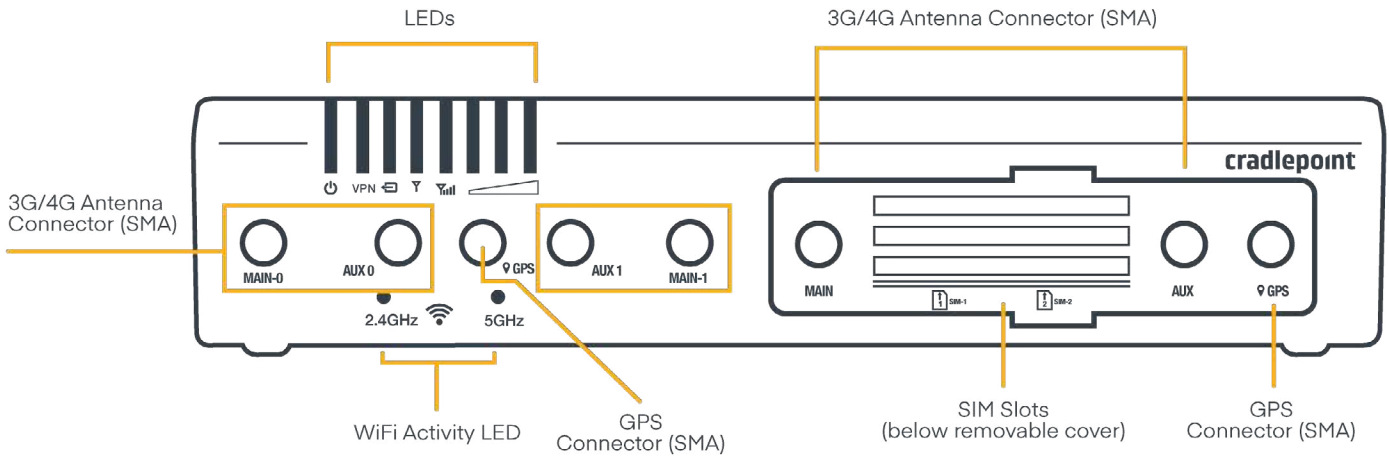

Front

AER2200-1200M-B shown





## LEDs

Indicator	Behavior
	<p><b>Power:</b> The Cradlepoint AER2200 must be powered using an approved 54 V DC power source.</p> <ul style="list-style-type: none"> <li>— Green = Powered ON.</li> <li>— Amber = Attention is required. Open the administration pages in NCM and check the router status.</li> <li>— No Light = Not receiving power. Check the power switch and source connection.</li> </ul>
<b>VPN</b>	<p><b>VPN:</b> Indicates status of VPN connection.</p> <ul style="list-style-type: none"> <li>— Blue = Connected to an active VPN.</li> </ul>
	<p><b>Removable MC400 Modem:</b> Indicates the status of removable MC400 modem(s).</p> <ul style="list-style-type: none"> <li>— Green = Modem has established an active connection.</li> <li>— Blinking Green = Modem is connecting.</li> <li>— Blinking Amber = Data connection error. No modem connection possible.</li> <li>— Blinking Red = Modem is in the process of resetting.</li> </ul>
	<p><b>Embedded Modem:</b> Indicates information about the embedded modem.</p> <ul style="list-style-type: none"> <li>— Green = Modem has established an active connection.</li> <li>— Blinking Green = Modem is connecting.</li> <li>— Amber = Modem is not active.</li> <li>— Blinking Amber = Data connection error. No modem connection possible.</li> <li>— Blinking Red = Modem is in the process of resetting.</li> <li>— Blinking Red with Signal Strength LEDs = SIM door is not installed, modem is off.</li> <li>— No Light = Modem not connected.</li> </ul>
	<p><b>Signal Strength:</b> Blue LED bars indicate the active modem's signal strength (only for integrated and removable modems).</p> <ul style="list-style-type: none"> <li>— 4 Solid Bars = Strongest signal.</li> <li>— 1 Blinking Bar = Weakest signal. (A blinking bar indicates half of a bar.)</li> <li>— 4 Blinking Bars = SIM door is not installed, modem is off.</li> </ul>
<b>2.4GHz 5GHz</b>	<p><b>WiFi Status:</b> Indicates information about WiFi channels.</p> <ul style="list-style-type: none"> <li>— 2.4 GHz Green = Activity on 2.4 GHz WiFi band.</li> <li>— 5 GHz Blue = Activity on 5 GHz WiFi band.</li> </ul>
<b>Other</b>	<p><b>Additional LED Indications:</b></p> <ul style="list-style-type: none"> <li>— Several different LEDs blink when the factory reset button is detected.</li> <li>— Two of the modem LEDs blink red in unison for 10 seconds when there is an error during NCOS upgrade.</li> <li>— When an external USB modem is plugged in, only the Signal Strength LEDs will light up.</li> </ul>